

MSR 127/22/25 Series

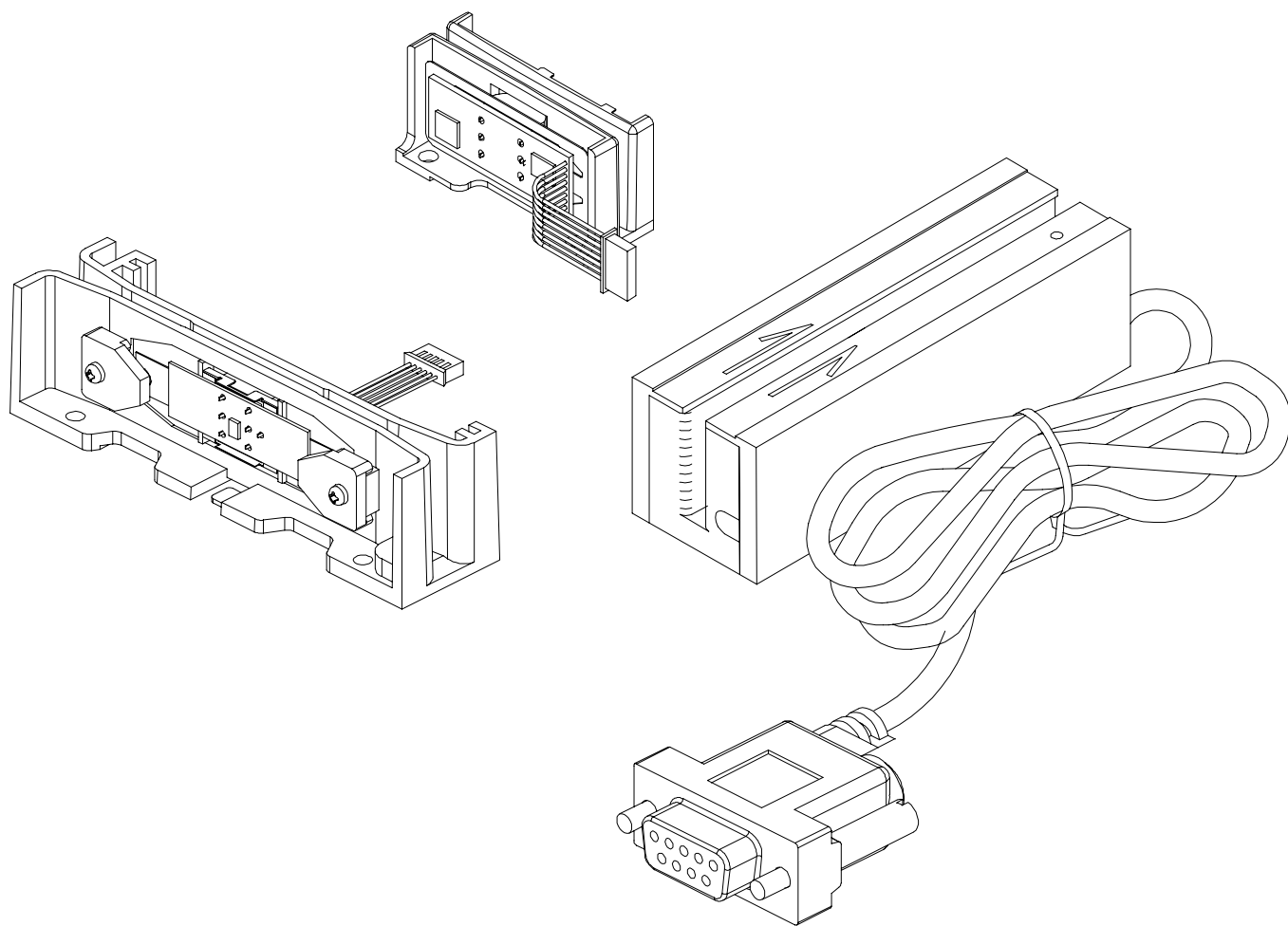

Magnetic card reader User's Manual

TM951175

Contents

Information	1
Technical And Operational Description	3
Connections	4
Card Data Format	6
Demo Software	7
Specifications	13

FCC COMPLIANCE STATEMENT





This equipment has been tested and found to comply with the limits for a Class A digital device, pursuant to Part 15 of the FCC Rules. These limits are designed to provide reasonable protection against harmful interference when the equipment is operated in a commercial environment. This equipment generates, uses, and can radiate radio frequency energy and, if not installed and used in accordance with the instruction manual, may cause harmful interference to radio communication.

Operation of this equipment in a residential area is likely to cause harmful interference in which case the user will be required to correct the interference at his own expense.

NOTE : The specification is subject to change without notice.

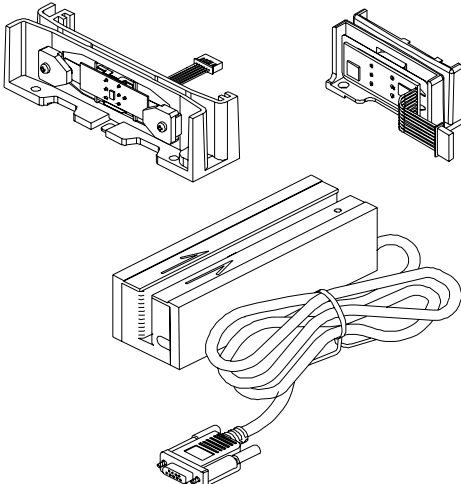
Information

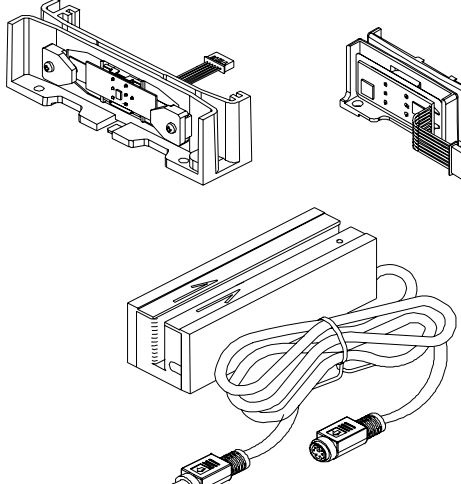
MSR127/22/25 Series Magnetic Swipe Reader

MACHINE TYPE	FUNCTION
 <p data-bbox="247 996 742 1086">MSR127R/22R/25R-00 MSR127L/22L/25L-00</p>	<div data-bbox="938 542 1114 645"> <p>MC 123</p> </div> <div data-bbox="1193 542 1369 645"> <p>JIS 123</p> </div> <div data-bbox="938 707 1114 810"> <p>BEEP</p> </div> <div data-bbox="1193 707 1369 810"> <p>RS-232</p>  </div>
 <p data-bbox="247 1691 742 1736">MSR127K/22K/25K-00</p>	<div data-bbox="938 1182 1114 1285"> <p>MC 123</p> </div> <div data-bbox="1193 1182 1369 1285"> <p>JIS 123</p> </div> <div data-bbox="938 1348 1114 1451"> <p>BEEP</p> </div> <div data-bbox="1193 1348 1369 1451"> <p>KEYBOARD</p>  </div>
<p data-bbox="279 1870 710 1926">Option Function</p>	<div data-bbox="949 1825 1125 1928"> <p>IBM 123</p> </div> <div data-bbox="1189 1825 1364 1928"> <p>iBUTTON</p>  </div> <div data-bbox="949 1977 1125 2080"> <p>AAMVA 123</p> </div>

■ Standard Package

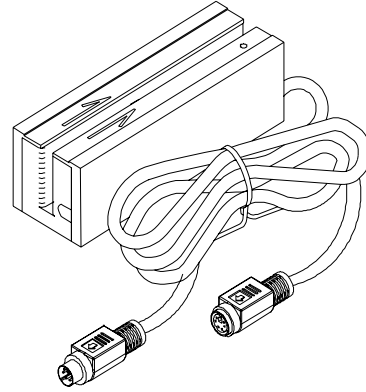
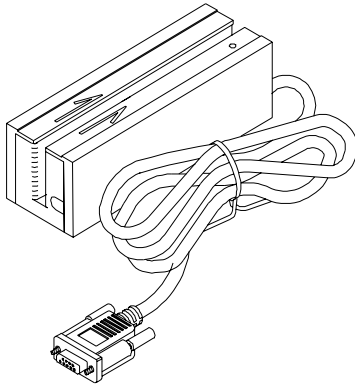

Main unit
(MSR25R/MSR25K)



Software Disk
(DISK5296)

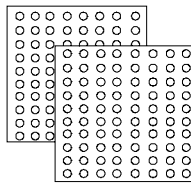

Velcro Pack
(M09-P601-036)
(M09-P602-036)

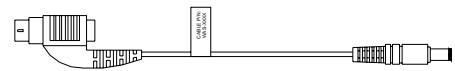

WAS-1536
(only for MSR25R)

■ Optional

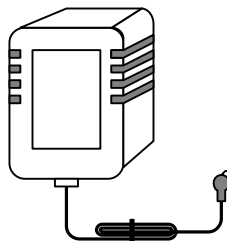

Power Adaptor
DC5V/120VAC (APR-1024)
or DC5V/230VAC (APR-1010)

Technical And Operational Description

■ Front Panel Display and Operations

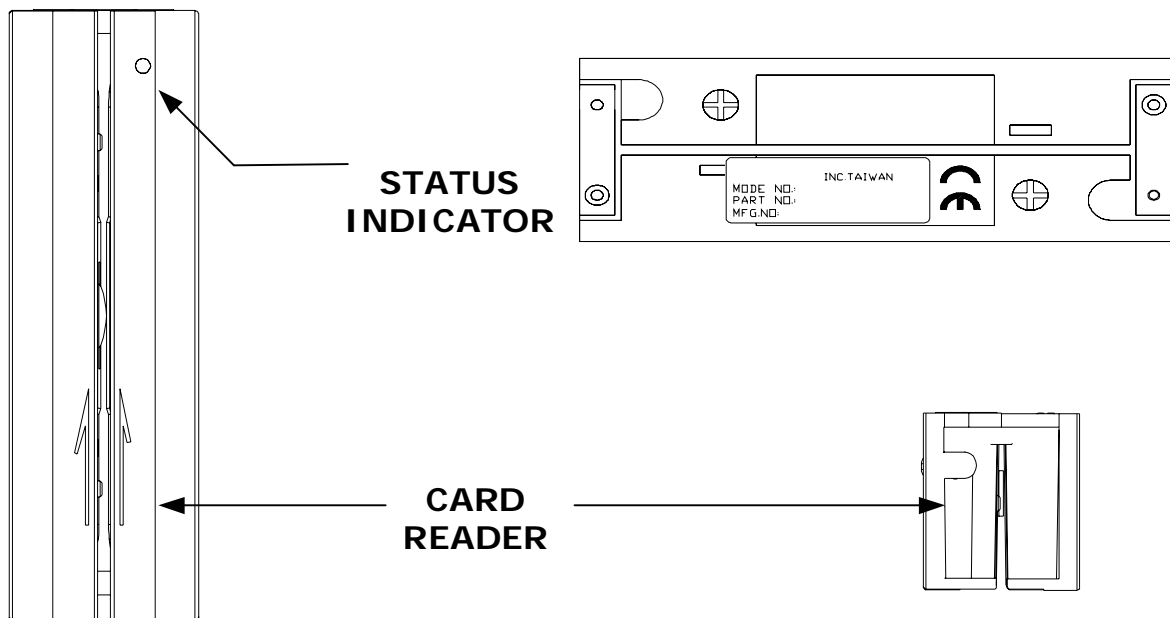

- **CARD READER**
Swipe the card through the entire length of the slot to read.
- **ERROR INDICATOR (Red color)**
When encountering erroneous input, defective card, misread, or incorrectly encoded data, the device will turn on the ERROR indicator .
- **READY INDICATOR (Green color)**
Indicating the reader is ready to accept new inputs.

■ Display Information

STATUS	GREEN LED	RED LED	BUZZER	READ CARD
POWER ON	BLINK 2 TIMES	BLINK 2 TIMES	Be-Bu-Be-Bu	X
READY	ON	OFF	X	O
READ OK	BLINK 1 TIME	OFF	Be	X
READ ERROR	OFF	ON	Be-Bu-Bu	X

Connections

MSR25R

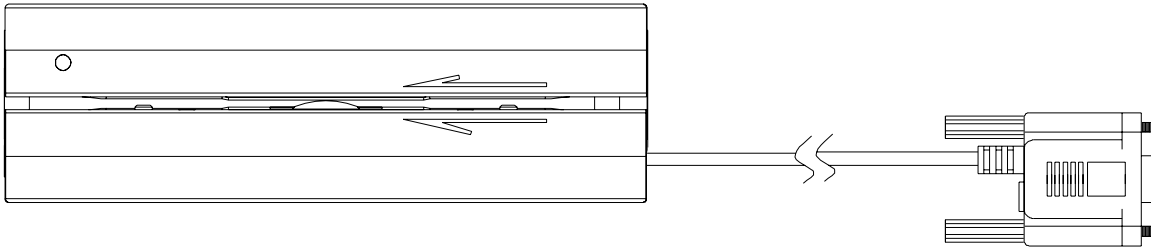

DSB 9P FEMALE PIN *	FUNCTION	COLOR
3	RX	YELLOW
2	TX	WHITE
5	GND	BLACK
DC JACK	VCC	RED

MSR25K

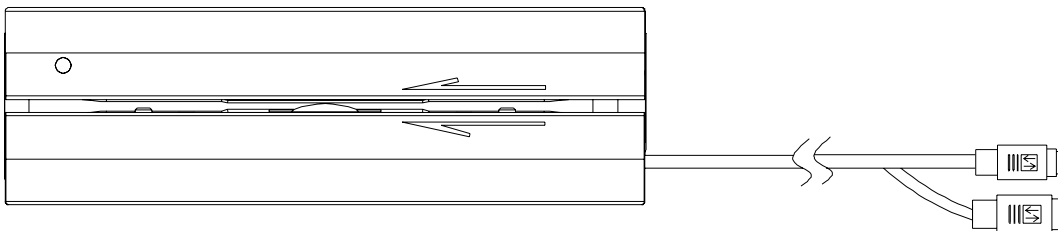

PS/2 MALE PIN	FUNCTION	COLOR	PS/2 FEMALE PIN	FUNCTION	COLOR
1	PC_DATA	WHITE	1	KB_DATA	BLUE
2	---	---	2	---	X
3	GND	RED	3	GND	RED
4	VCC	YELLOW	4	VCC	YELLOW
5	PC_CLK	BLACK	5	KB_CLK	PURPLE
6	---	---	6	---	YELLOW

MSR22R/MSR22L/MSR22K

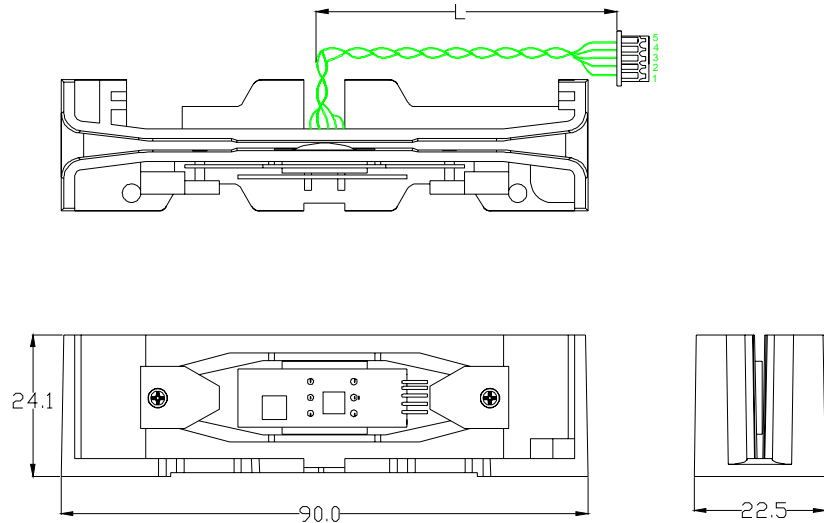

PIN No.	COLOR	RS232 FUNCTION	RS232 TTL FUNCTION	PS/2 FUNCTION
1	PURPLE	CASE	CASE	CASE
2	BLACK	GND	GND	GND
3	RED	VCC 5.0V	VCC 5.0V	VCC 5.0V
4	YELLOW	TX	TX	KB_CLOCK
5	WHITE	RX	RX	KB_DATA
6	GEEEN	---	---	PC_CLOCK
7	BLUE	---	---	PC_DATA

MSR127R/MSR127L/MSR127K

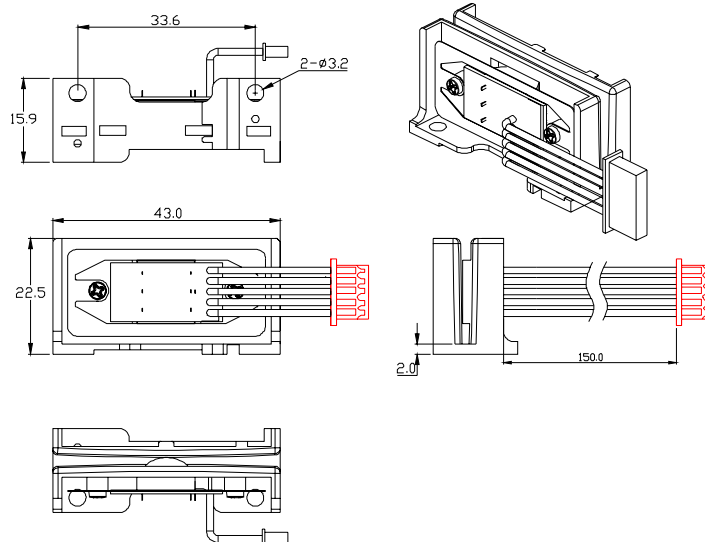

PIN No.	COLOR	RS232 FUNCTION	RS232 TTL FUNCTION	PS/2 FUNCTION
1	PURPLE	CASE	CASE	CASE
2	BLACK	GND	GND	GND
3	RED	VCC 3.3V	VCC 3.3V	VCC 3.3V
4	YELLOW	TX	TX	KB_CLOCK
5	WHITE	RX	RX	KB_DATA
6	GEEEN	---	---	PC_CLOCK
7	BLUE	---	---	PC_DATA

Card Data Format

CARD DATA STRING

TRACK 1			TRACK 2			TRACK 3		
SS	TRACK1 DATA	ES	SS	TRACK2 DATA	ES	SS	TRACK3 DATA	ES
%	TRACK1 DATA	?	;	TRACK2 DATA	?	+	TRACK3 DATA	?

TRACK 1

%	CARD ID	?
---	---------	---

1. SS is the start sentinel (%).
2. ES is the end sentinel (?).
3. Card Id up to 76 alphanumeric data characters.

Track 1 IATA	
Bits Per Inch	210
Bits Per Character	7
Alphanumeric Characters	79

TRACK 2

;	CARD ID	?
---	---------	---

1. SS is the start sentinel (;).
2. ES is the end sentinel (?).
3. Card Id up to 37 numeric data characters.

Track 2 ABA	
Bits Per Inch	75
Bits Per Character	5
Numeric Characters	40

TRACK 3

+	CARD ID	?
---	---------	---

1. SS is the start sentinel (+).
2. ES is the end sentinel (?).
3. Card Id up to 104 numeric data characters.

Track 3 Thrift	
Bits Per Inch	210
Bits Per Character	5
Numeric Characters	107

Note: Track 3 can read both ISO TK3 format and ISO TK1 format.

■ Option

iBUTTON DATA STRING:

STATUS	DS1990A 48-Bit Serial Number
--------	------------------------------

STATUS	61 : iButton Press 75 : iButton Release
--------	--

a	@	DS1990A 48-Bit Serial Number	?
---	---	------------------------------	---

u	@	DS1990A 48-Bit Serial Number	?
---	---	------------------------------	---

Demo Software

Apply the bundled disk no. 5296 to begin with the demo software.

STEP 1 : Run MSR Configure

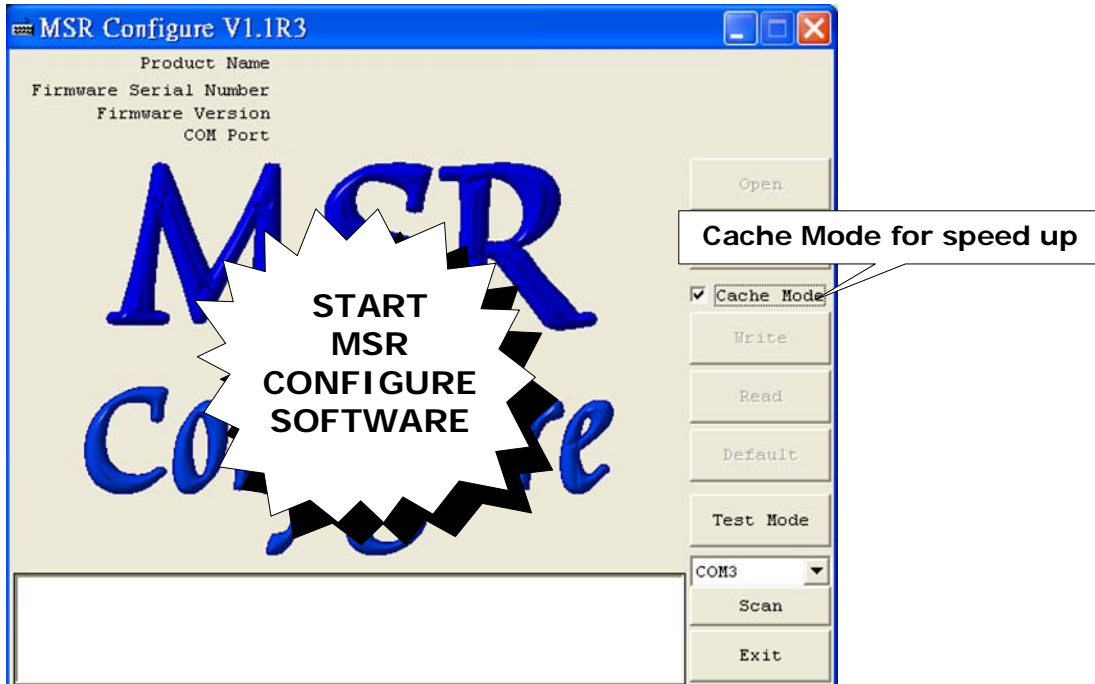

STEP 2 : Choose PS/2 or COM port and press "Scan", connect the MSR22/25 reader.

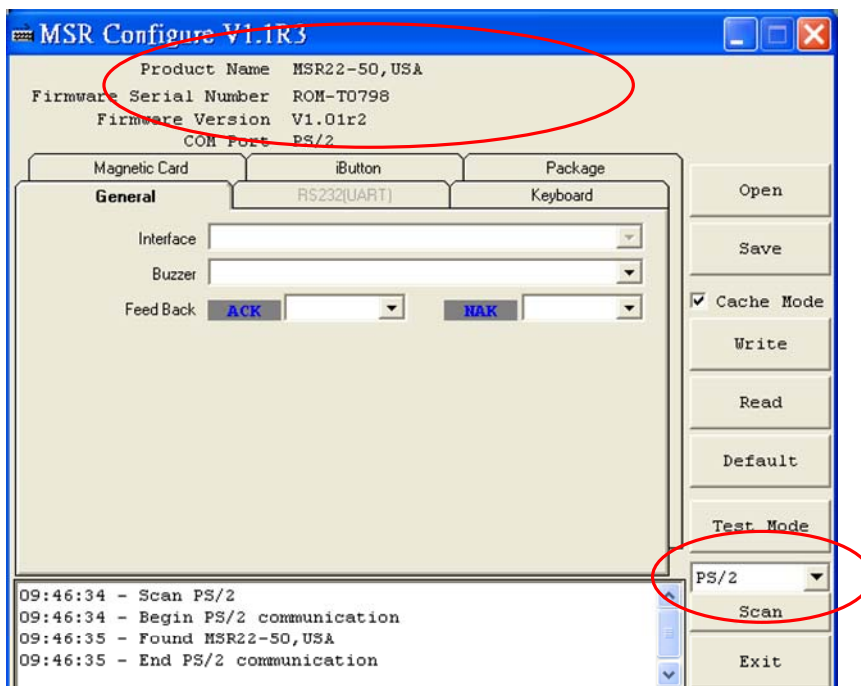

STEP3 : Click "Read" ,scan the MSR22/25 reader parameter.

General :

- Interface** : MSR Interface is being detected.
- Buzzer** : Choose buzzer enable or disable.
- Feed Back** : Set MSR output data ,waiting for feedback from the terminal.
Show 'Error' message if no reaction from MSR

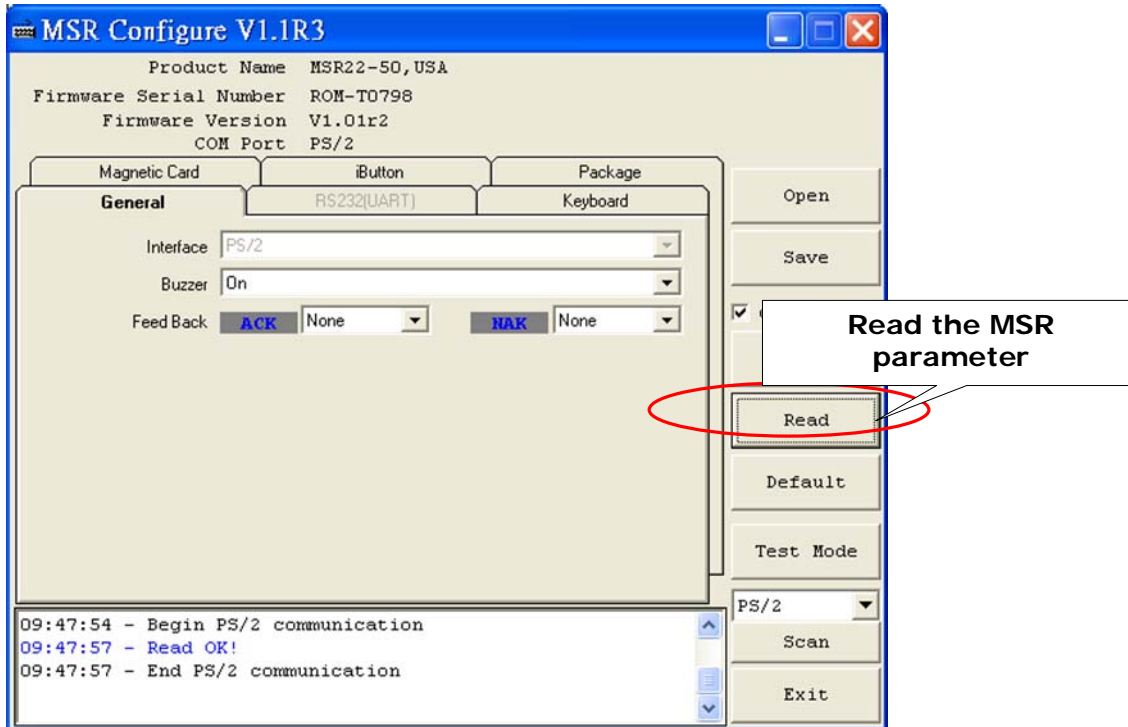

RS232(UART) : Setting MSR communication parameter ,when RS232 and serial USB enable .

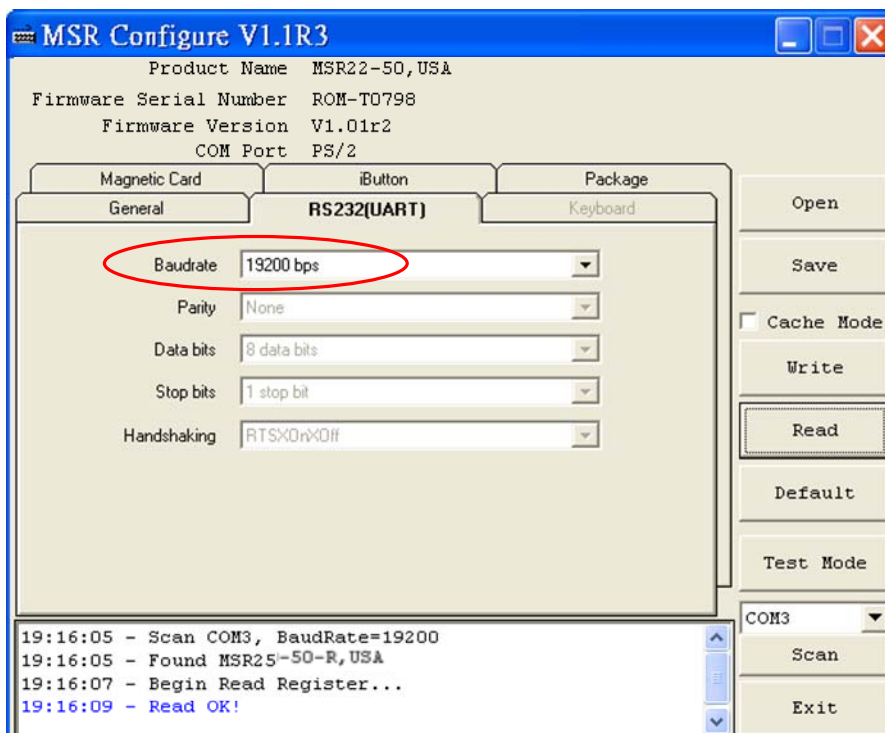

Keyboard : Setting MSR language ,when keybpard enable .

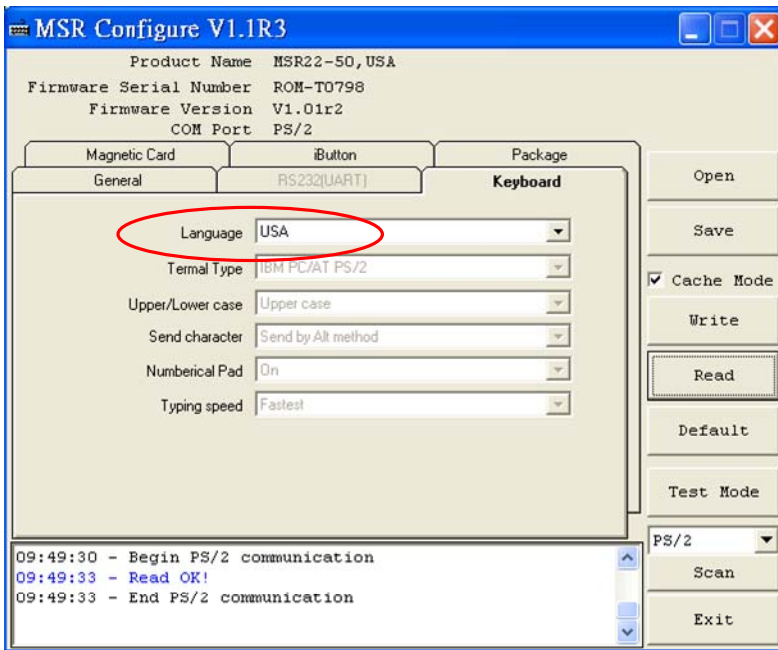

Package : Setting MSR & iButton data output package .

Data Format :



MSR Data Package :



iButton Data Package :



FS : Package leading character.

FE0 : Package ending character.

FE1 : Package ending character.

check : Bit check up.

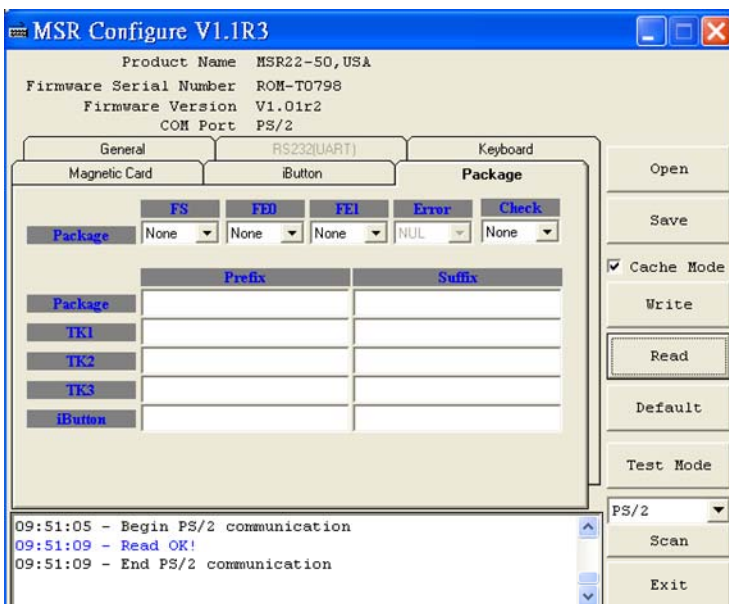

iButton : Set iButton data format .

Data format :



SS : Start Sentinel

ES : End Sentinel

PS : iButton present prompt character.

RS : iButton Release prompt character.

Present ID format : Set present iButton output ID format .

Release ID format : Set release iButton output ID format .

Family Code : Terms for iButton series.

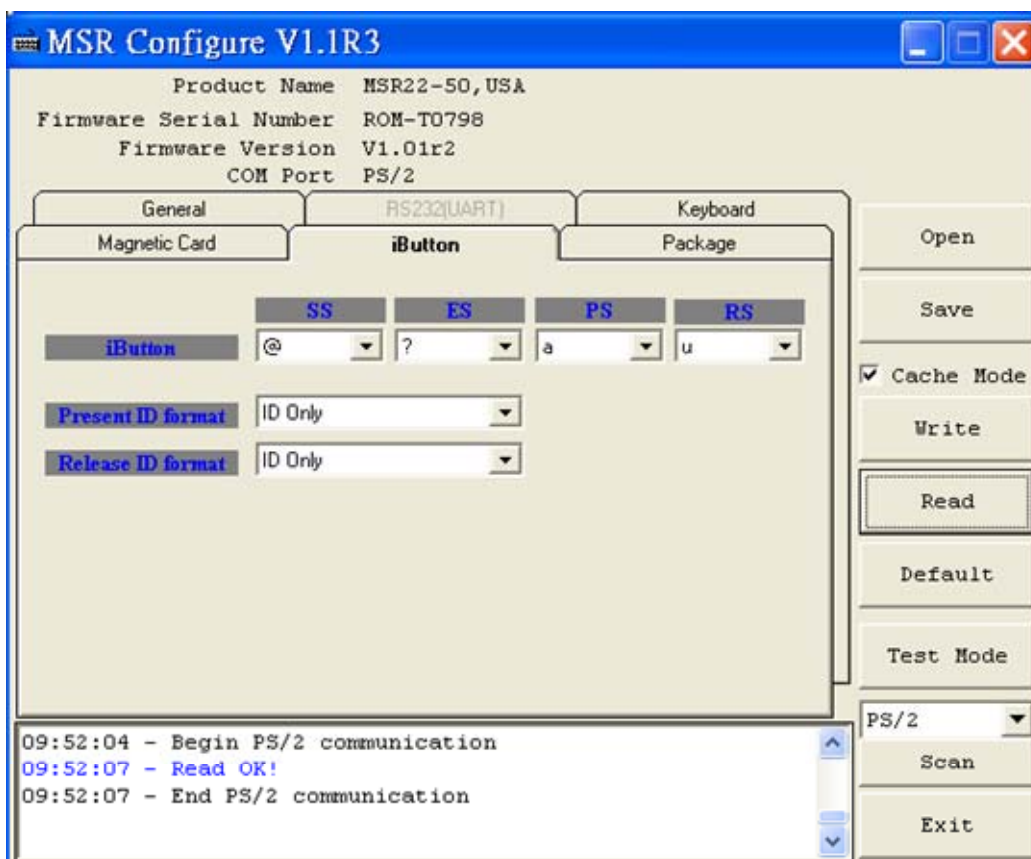

Magnetic Card : Set MSR data format and data output parameter .

Data format :



MSR package :



Mark Code : Leading character to set up output data.

Decode Mode : To decode magstripe data.

Decode Standard : To decode magstripe format.

7Bit : 7 Bits Per Character data.

ABA : 5 Bits Per Character data .

JIS2 : JIS2 data format.

AAMVA : AAMVA data format .

IBM : IBM data format .

SS : Start Sentinel

ES : End Sentinel

TK ESO : Ending prompt character .

TK ES1 : Ending prompt character .

Track Output Order : To set up track data in turn.

Track Length : To set up track data length.

Swipe Card Direction : To set up prompt character for direct/reverse side card swipe prompt character.

FF : To set up direct side cardswipe prompt character.

RR : To set up reverse side cardswipe prompt character.

Head Compatible : To set up the decoding work for IBM or JIS2 data output at one time only.

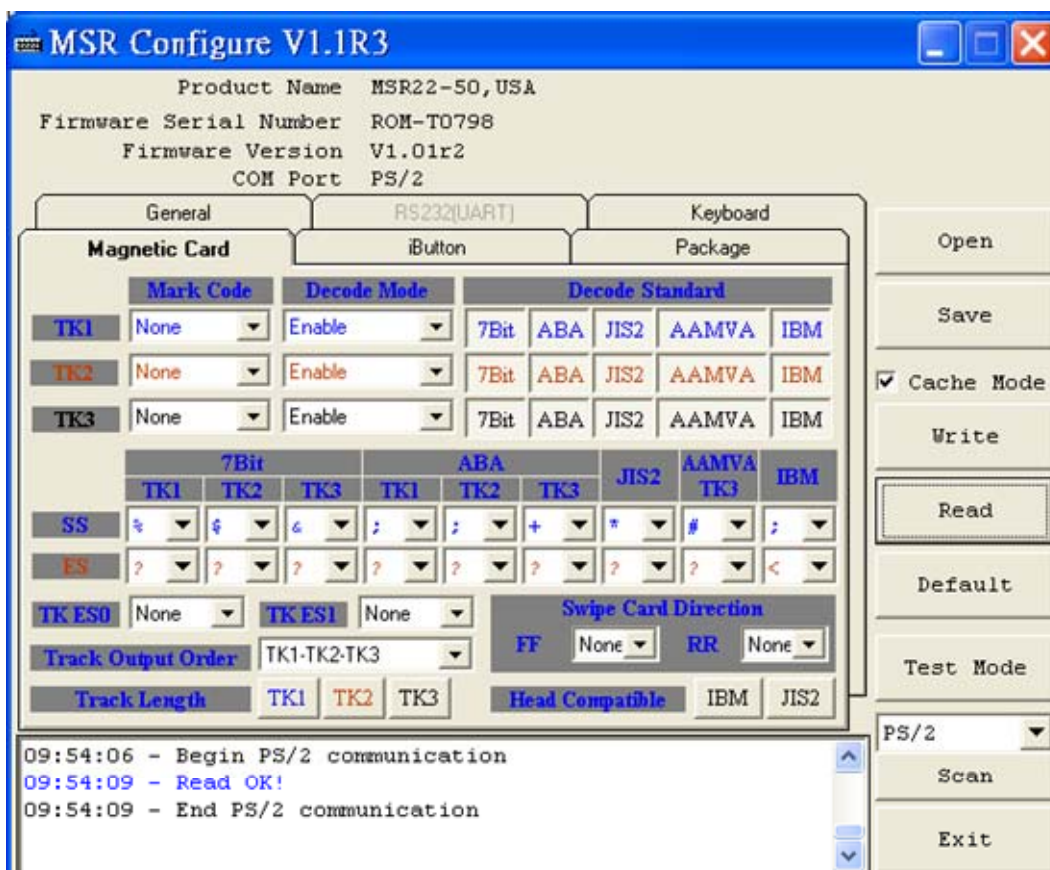

Specifications

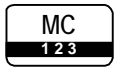

Magnetic Stripe Card :

TRACK 1 / IATA / 210 bpi / 79 Alphanumeric Characters
TRACK 2 / ABA / 75 bpi / 40 Numeric Characters
TRACK 3 / Thrift / 210 bpi / 107 Numeric Characters



RS232 Interface :

RS232 , Half-Duplex , 8N1 , 1200~19200 bps



RS232 TTL Interface :

RS232 TTL, Half-Duplex , 8N1 , 1200~19200 bps



PS/2 Interface :

PC keyboard interface , Scan code



Power Supply :

DC 3.3V, 300mA for MSR127R/127L/22R/22L (**Optional DC 5V**)
DC 5V, 300mA for MSR127K/22K/25R/25K

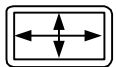

Dimensions :

D 15.9 x W 43 x H 22.5 mm (MSR127 without cover)
D 23 x W 90 x H 24 mm (MSR22 without cover)
D 33 x W 100 x H 31 mm (MSR25 with cover)

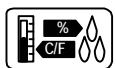

Environment :

Operating Temp : 0 ~ 55 Deg.C
Storage Temp : -10 ~ 55 Deg.C
Humidity : 10 ~ 90 % relative

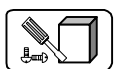

Mounting :

Portable or Any surface